

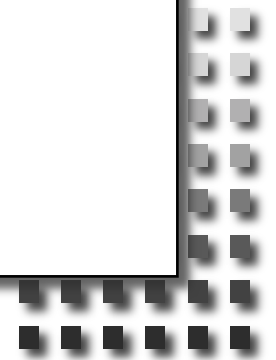

# IETF Structure and Internet Standards Process

*Scott Bradner*

*72nd IETF  
Dublin, Ireland*





# Agenda

history & overview

role & scope

structure & associated groups

management & selection

process & procedure

working group session

IPR



I E T F®

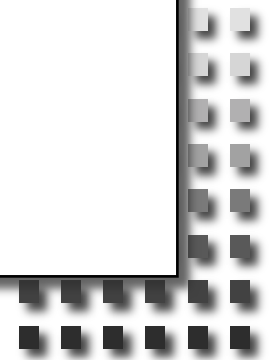

# The IETF

Internet Engineering Task Force  
formed in 1986

evolved out of ARPA's Internet Configuration Control Board (ICCB) (1979) and Internet Activities Board (1983)

was not considered important for a long time - good!!  
not government approved - great!!

but funding support from U.S. Government until 1997

people not companies

*“We reject kings, presidents and voting. We believe in rough consensus and running code”*

Dave Clark (1992)



# IETF Overview

Internet standards R us

does not exist (in a legal sense), **no** members, **no** voting  
1K to 2K people at 3/year meetings

many many more on mail lists

107ish **working groups** (where the stuff happens)

8 **areas** (for organizational convenience) with **ADs**

APS, GEN, INT, O&M, RAI, RTG, SEC, TSV

**IESG**: management (ADs + IETF Chair)

**IAB**: architectural guidance & liaisons

produces **standards** and other documents



I E T F®



# IETF “Standards”

IETF standards: not standards “because we say so”  
standards only when people **use** them

formal SDOs can create legally mandated standards

**no** formal recognition for IETF standards

by governments or “approved” standards organization

lack of formal government input “a problem”

at least to some governments

**no** submitting to “traditional” bodies



# The Role & Scope of the IETF

*“above the wire and below the application”*

IP, TCP, email, routing, IPsec, HTTP, FTP, ssh, LDAP,  
SIP, mobile IP, ppp, RADIUS, Kerberos, secure email,  
streaming video & audio, ...

but wires are getting fuzzy

MPLS, GMPLS, pwe3, VPN, ...

generally hard to clearly define IETF scope

constant exploration of edges



# Scope of Other SDOs

Internet (and Internet protocols) very interesting to other standards development organizations (SDO)

other SDOs trying “fix” or “extend” IETF protocols

they may be trying to solve a different problem

or are making different assumptions

problem: what happens when these extensions break underlying protocol assumptions or make non-interoperable versions?

SDO (including IETF) assumption: each SDO modifies its own protocols --- but - see note to ITU-T

[https://datatracker.ietf.org/public/liaison\\_detail.cgi?detail\\_id=127](https://datatracker.ietf.org/public/liaison_detail.cgi?detail_id=127)



I E T F®

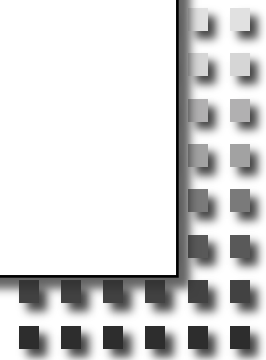

# Top Level View of Organization

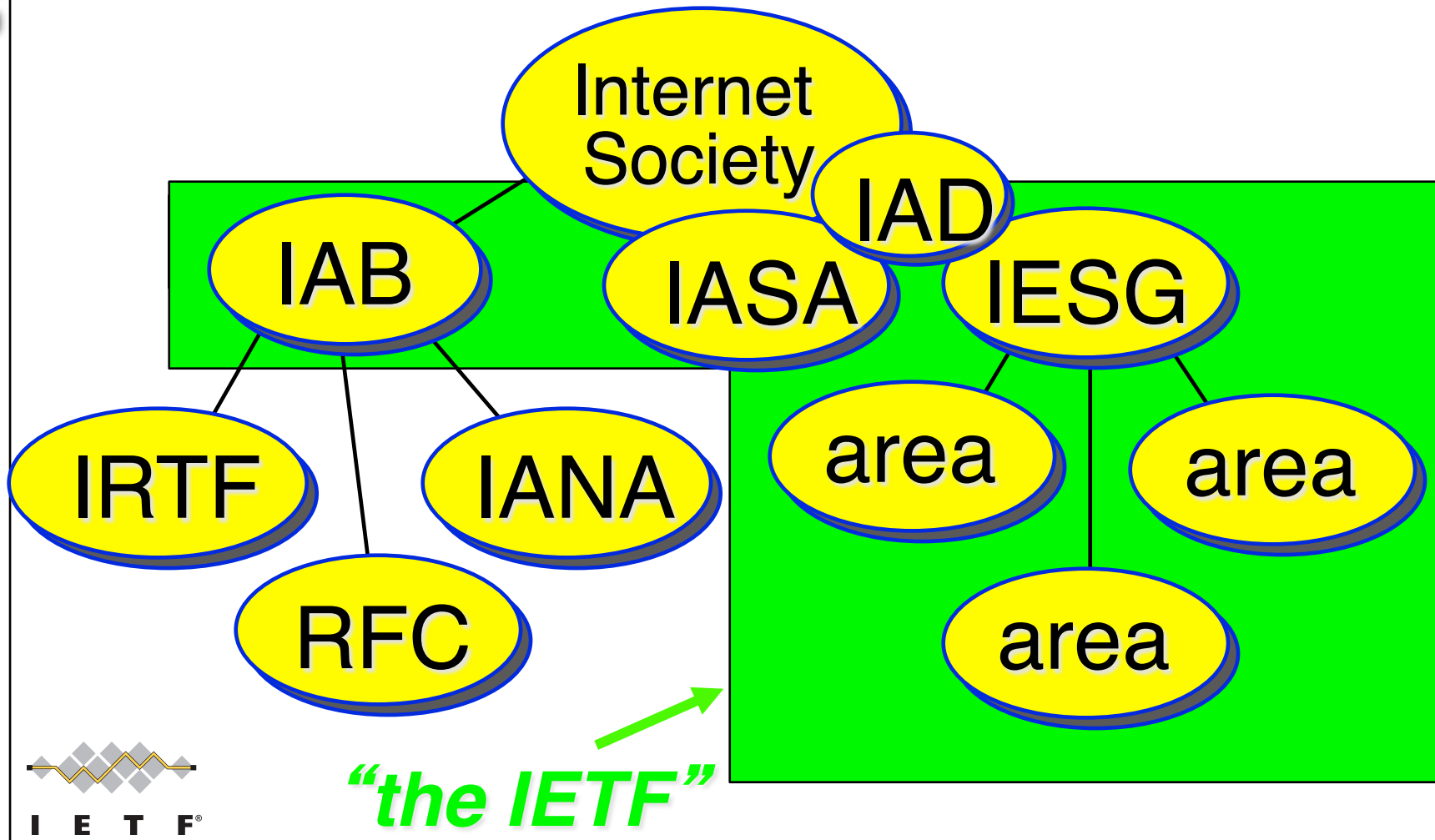

# The Internet Society (**ISOC**)

non-profit, non-governmental, international,  
professional membership organization

more than 80 organizational members & more than 28,000  
individual members in over 90 chapters around the world

organizational and administrative home for IETF

legal umbrella, insurance, IASA home, IAD employer, etc

ISOC Board of Trustees part of appeal chain

ISOC President appoints chair of nomcom

IAB chartered by ISOC

ISOC president is on the IAB list & calls

IETF (through IAB) appoints 3 ISOC trustees



join at [www.isoc.org](http://www.isoc.org)

# Internet Research Task Force (IRTF)

focused on **long term** problems in Internet

Anti-Spam Research Group (ASRG)

Crypto Forum Research Group

Delay-Tolerant Networking Research Group (DTNRG)

End-to-End Research Group

Host Identity Protocol Research Group (HIP)

IP Mobility Optimizations (Mob Opts) Research Group

Network Management Research Group Charter (NMRG)

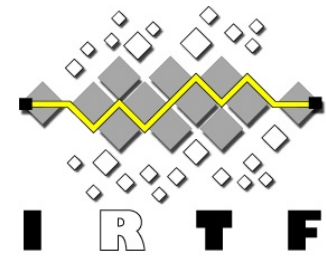



# IRTF, contd.

Peer-to-Peer Research Group

Routing Research Group

Transport Modeling Research Group

Internet Congestion Control Research Group

Scalable Adaptive Multicast Research Group

most groups are open, some invitation only

IRTF Chair: Aaron Falk

for more information see <http://www.irtf.org>



# Internet Architecture Board (IAB)

provides overall **architectural advice** & **oversight**  
to IESG, IETF & ISOC

approves IESG slate from nomcom

step in appeals chain

provides “oversight” of IETF standards process

deals with IETF external liaisons

appoints IRTF chair

selects IETF-IANA

appoints & oversees RFC Editor

chartered by the ISOC



I E T F®

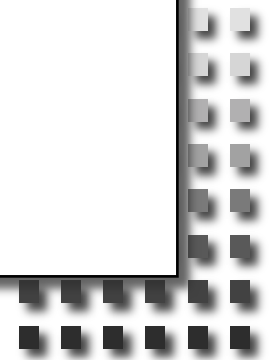





# IAB Oversight Mechanisms

review BOFs

provide input to IESG on WG formation & charters

sponsor & organize IRTF

convene topic-specific workshops

mostly invitation only

organize ad-hoc expert groups to adjudicate technical disputes

write IDs/RFCs stating IAB opinion

community & IESG review

participate in WG discussions



I E T F®

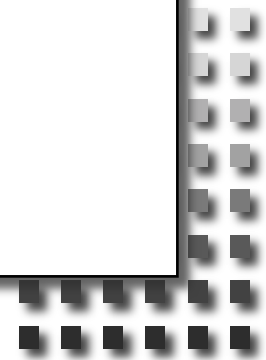



# IAB Members

Loa Andersson

Gonzalo Camarillo

Stuart Cheshire

Russ Housley

(as IETF Chair)

Olaf Kolkman

(IAB chair)

Gregory Lebovitz

Barry Leiba

Kurtis Lindqvist

Andy Malis

Danny McPherson

David Oran

Dave Thaler

Lixia Zhang



I E T F®

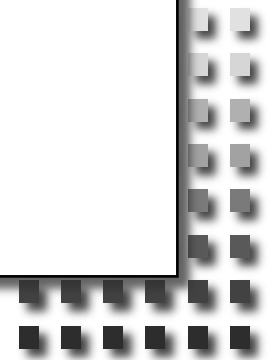



# Internet Assigned Number Authority (**IANA**)

assigns numbers and keeps them from colliding  
protocol numbers (ports, MIME types, etc)

IP addresses

- mostly delegated to 5 regional IP Address registries

domain names

- deals with top level domains (TLDs - e.g., .com, .ca, .us, ...)

- mostly delegated to DNS name registries

functions split from IETF with the creation of **ICANN**

Internet Corporation for Assigned Names and Numbers

(semi) independent corp. to take over IANA functions

- under (continuing) contract with US government

- now IETF-IANA and non-IETF-IANA



**I E T F**<sup>®</sup>

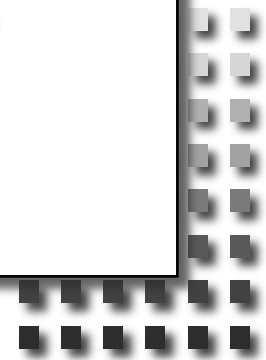



# IETF-IANA

operates under MoU between ICANN and IETF  
RFC 2860

assigns protocol parameters for IETF protocols  
but not paid for by IETF

IP protocol numbers

well known TCP/UDP ports

PPP protocol ids

MIME types

etc.



I E T F®

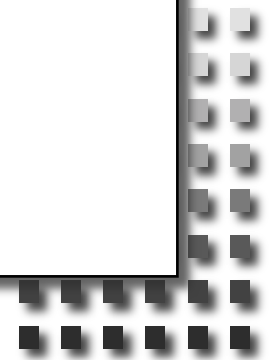



# IETF Management

## IETF Chair

AD for General Area, chief spokesman

## Area Directors (ADs)

manage individual areas

## Internet Engineering Steering Group (IESG)

ADs sitting as a body (includes IETF Chair)

## Internet Architecture Board

IETF chair also

IETF Chair, ADs & IAB members selected by nomcom

two year terms



I E T F®

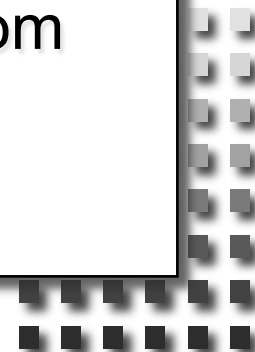



# IETF Management, contd.

all volunteers

AD job: half to 3/4 time

IAB job: 1/3 time

IETF Chair job: full time

IETF does not pay ADs, IAB members, IAOC members, or IETF Chair a salary or expenses

company or self-supported

secretariat personnel are paid

# IETF Chair

Russ Housley <chair@ietf.org>

also chair of the **IESG**

also AD of the **General Area**

also ex officio member of the **IAB**

nominated by IETF community - this now includes you  
selected by nomcom

IETF's "CTO" - "Chief Talking (& Traveling) Officer"



# Area Directors (ADs)

Areas have 2 ADs

except General Area

responsible for setting direction in Area

responsible for managing process in Area

approve BOFs & working groups

charters then go to IESG & IAB for final approval

review working group documents

prior to IESG review





# IESG

Internet Engineering Steering Group

ADs + IETF Chair

**process management and RFC approval body**

approves WG creation (with IAB advice)

**provides technical review** & approves publication of IETF documents

reviews and comments on non-IETF submissions

**multi-disciplinary technical review** group



# Selecting IETF Management

picked by a nominations committee (nomcom)

nomcom chair appointed by ISOC president

process described in RFC 3777

members selected randomly from list of **volunteers**

requirement: you were at 3 of last 5 IETF meetings

very random process to select from volunteers: RFC 3797

get list of jobs to fill from IETF chair

IETF Chair, IESG, IAB & IAOC members

nominate one person for each job

IESG & IETF Chair approved by IAB, IAB approved by

ISOC BoT, IAOC approved by IESG



I E T F®

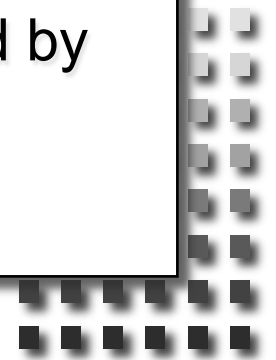



# IETF Areas

IETF Chair & AD for General Area (**gen**) (1 WG)

Russ Housley

Applications (**app**) (10 WGs)

Lisa Dusseault

Chris Newman

Internet (**int**) (28 WGs)

Jari Arrko

Mark Townsley

Operations & Management (**ops**) (18 WGs)

Ronald Bonica

Dan Romascanu



I E T F®

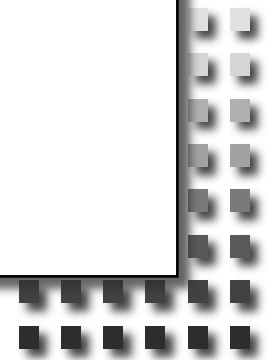



# IETF Areas (cont.)

Real-time Applications and Infrastructure (**rai**) (17 WGs)

Cullen Jennings

Jon Peterson

Routing (**rtg**) (16 WGs)

Ross Callon

Dave Ward

Security (**sec**) (16 WGs)

Pasi Eronen

Tim Polk

Transport Services (**tsv**) (12 WGs)

Lars Eggert

Magnus Westerlund



I E T F®

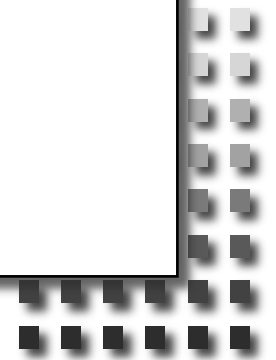



# IETF Secretariat

Association Management Solutions, LLC - Fremont, CA,  
USA

managed by IETF Administrative Support Activity (IASA)

runs

plenary meetings, mailing lists,

Internet-Draft directory, IESG teleconferences

coordinates

day to day work of IESG and working groups

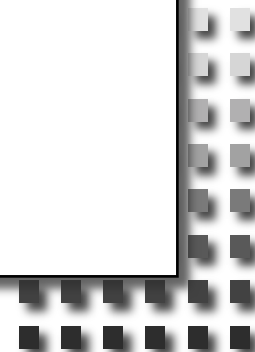

# IETF Administrative Support Activity (IASA)

provides the administrative structure required to support the IETF standards process: see RFCs 4071 & 4371

**has no authority over the standards process**

housed within the Internet Society

creates budget for IETF

money from meeting fees & from ISOC

responsible for IETF finances

contracts for IETF support functions

Secretariat functions, RFC Editor & IETF-IANA

deals with IETF IPR



# IASA, contd.

includes

IETF Administrative Director (**IAD**) - Ray Pelletier

ISOC employee

day to day operations oversight

IETF Administrative Oversight Committee (**IAOC**)

8-member body

IAB & IETF chairs & ISOC president (ex officio)

plus

members selected by nomcom (2), IAB, IESG & ISOC



# IAOC Membership

Bob Hinden, appointed by the IAB

Kurtis Lindqvist, appointed by the IESG (IAOC Chair)

Fred Baker, appointed by the ISOC Board of Trustees

Jonne Soininen, appointed by the NomCom (2 year term,  
appointed 2007)

Ed Juskevicius, appointed by the NomCom (2 year term,  
appointed 2008)

ex officio/non voting

the IETF Chair

the IAB Chair

the ISOC President/CEO

non voting

Ray Pelletier, IETF Administrative Director



I E T F®

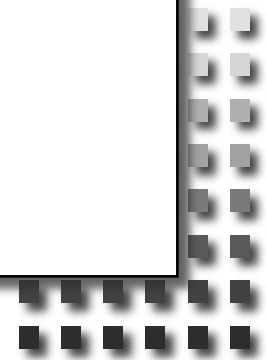





# IETF Trust

created in Dec 2005 to hold IETF IPR

copyrights (on RFCs etc)

domain names (e.g., ietf.org)

software paid for by IETF

databases

etc

required IPR licensed to provider of Secretariat Services

IPR created during secretariat contract goes to Trust

not a patent pool



I E T F®

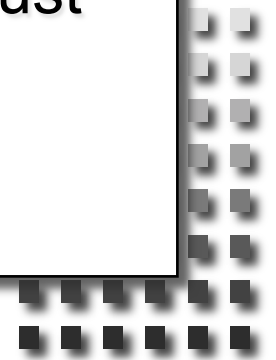

# Dots

-  IAB member (red)
-  IESG member (yellow)
-  Working Group chair (blue)
-  nomcom (orange)
-  Local host (green)
-  IAOC member (purple)



# Standards Procedure

proposals published as Internet Drafts (ID)

worked on in a Working Group

WG sends IESG request to publish an ID 'when ready'

proposal reviewed by AD

can be sent back to working group

IETF Last-Call (4-week if no Working Group)

IESG review

last call comments + own technical review

can be sent back to Working Group

publication as RFC



I E T F®

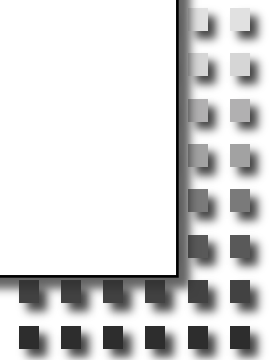



# Birds of a Feather Sessions (BOF)

often precede formation of a Working Group  
group of people interested in a topic

convince an AD that they have a good idea - one  
worth exploring & there are enough interested  
people to do the work

need description and agenda before a BOF can be  
scheduled

and sometimes a draft charter

BOFs generally only meet once

can lead to a W G or can be a one time thing



I E T F®

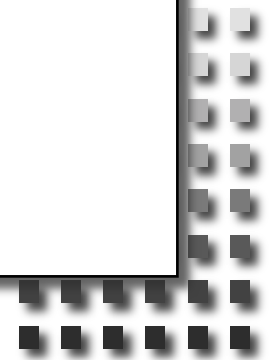



# Working Groups

this is where the IETF primarily get its work done

most discussions on WG mailing list

face-to-face meetings focused on key issues (ideally)

note: face-to-face meetings generally quite short

Working Groups are focused by charters agreed  
between WG chair(s) and area director

restrictive charters with milestones

working groups are closed when their work is done

charter approved by IESG with IAB advice

AD with IESG has final say on charter



I E T F®

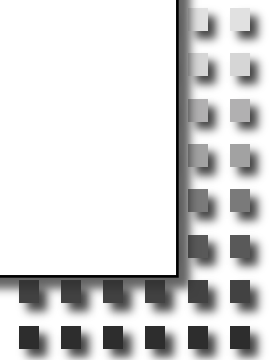

# Working Group Creation

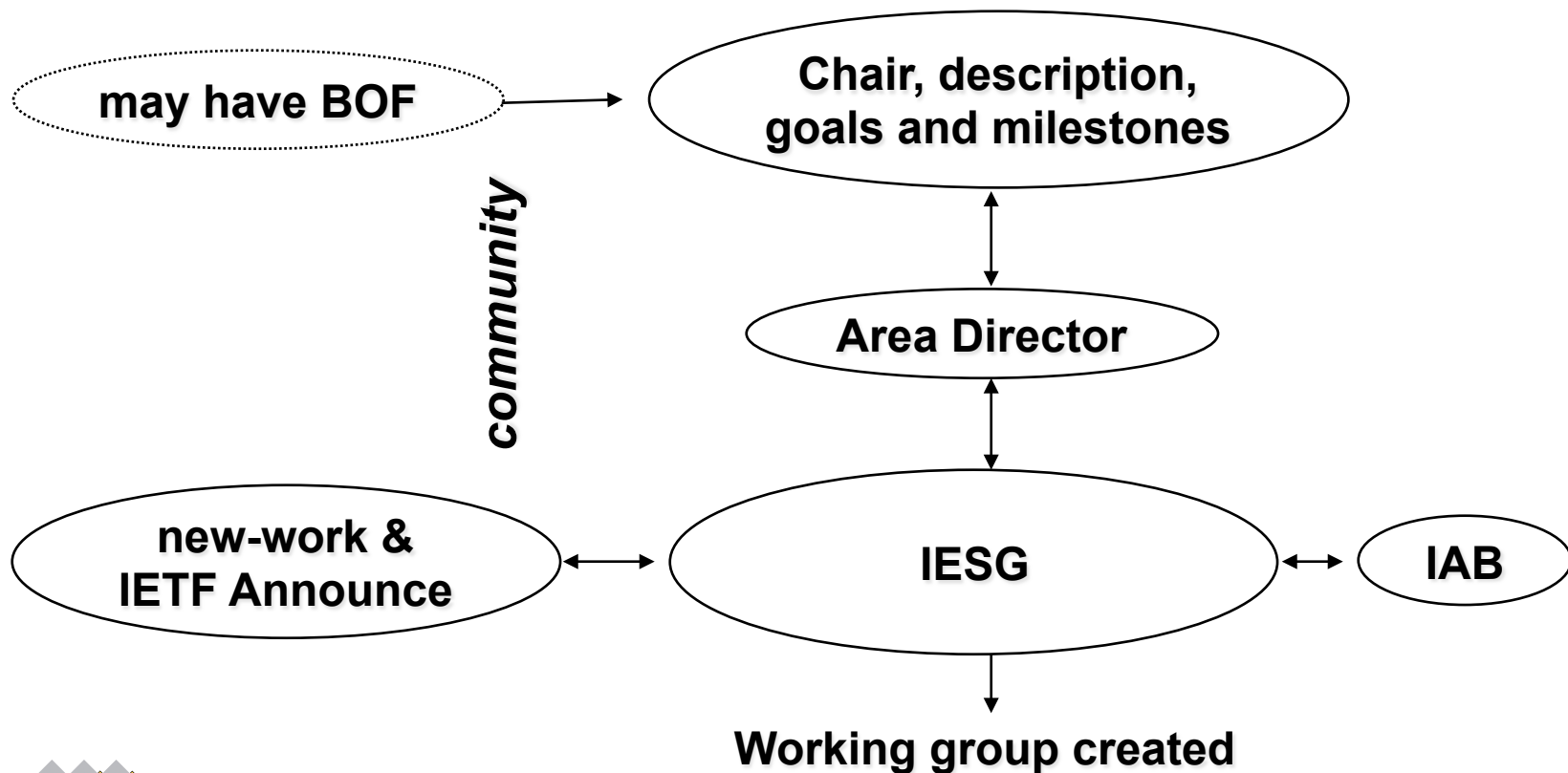



# Working Groups. contd.

no defined membership

just participants

“***Rough consensus** and running code...*”

no formal voting - can not define constituency

can do show of hands or hum - but **no** count

does **not** require unanimity

chair determines if there is consensus

disputes resolved by discussion

mailing list and face-to-face meetings

final decisions must be verified on mailing list

to ensure those not present are included

but taking into account face-to-face discussion



I E T F®

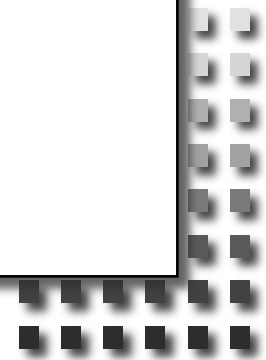



# IETF Document Format

English is the official language of the IETF

but blanket permission is given to translate any IETF document into any language

ASCII is the mailing list and document format

constant discussion of alternate formats

IETF seen as “behind the times” - e.g., (almost) no drawings  
but no consensus on alternative format

note that the current format is still readable after 39 years

how many other formats can claim that?



I E T F®

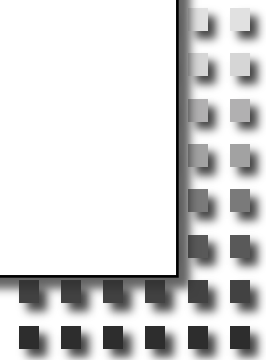





# IETF Documents

all IETF documents are **open**

i.e., anyone can download and make copies

## Internet Draft

IETF working documents

**some** I-Ds are working group documents

## RFC

archival publications (never changed once published)

update or correction gets new RFC number

many different types



I E T F®

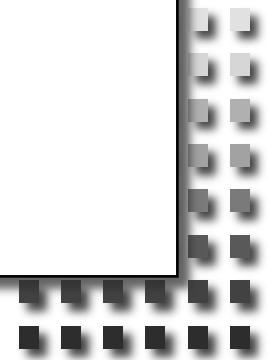



# IETF Working Documents

## Internet-Draft

random or non-random thoughts

input to the process

**no admissions control** other than boilerplate (see IPR)

in theory, removed from **IETF** directory after 6 months

unless under IESG consideration

but many mirrors exist, including in IETF Tools

all RFCs must pre-exist as IDs

to deal with IPR handoff

(other than some IANA or RFC Editor created ones)



I E T F®

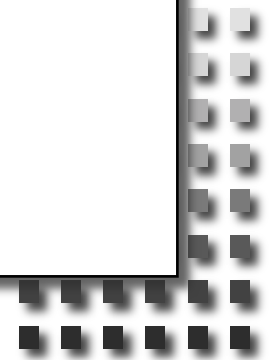



# What is a RFC?

RFC used to stand for “Request for Comments”

now just a (brand) name

now tend to be more formal documents than early RFCs

IETF document publication series

RFC 1 *Host Software* - Apr 7 1969

now over 4900 RFCs

**not all RFCs are standards!**

see RFC 1796

though some vendors imply otherwise

many types of RFCs



I E T F®

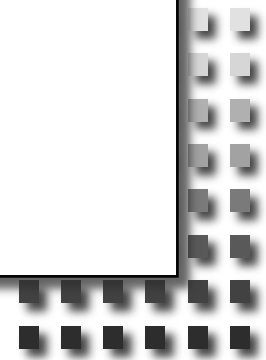

# RFC Repository Contains:

standards track

OSPF, IPv6, IPsec ...

obsolete Standards

RIPv1

requirements

Host Requirements

policies

Classless InterDomain

Routing

april fool's day jokes

IP on **Avian Carriers** ...

... updated for QoS

poetry

'Twas the night before startup

white papers

On packet switches with  
infinite storage

corporate documentation

Ascend multilink protocol (mp  
+)

experimental history

Netblt

process documents

IETF Standards Process



I E T F®

# RFC Editor

IETF publication arm

[rfc-editor@rfc-editor.org](mailto:rfc-editor@rfc-editor.org)

semi-independent

gets requests to publish IETF IDs from IESG

also gets requests to publish independent IDs for  
informational or experimental RFCs

asks IESG for advice on publishing independent RFCs

but can exercise own discretion

presumption is to publish technically competent IDs

which sometimes is a conflict with IESG



I E T F®

# IETF Submission

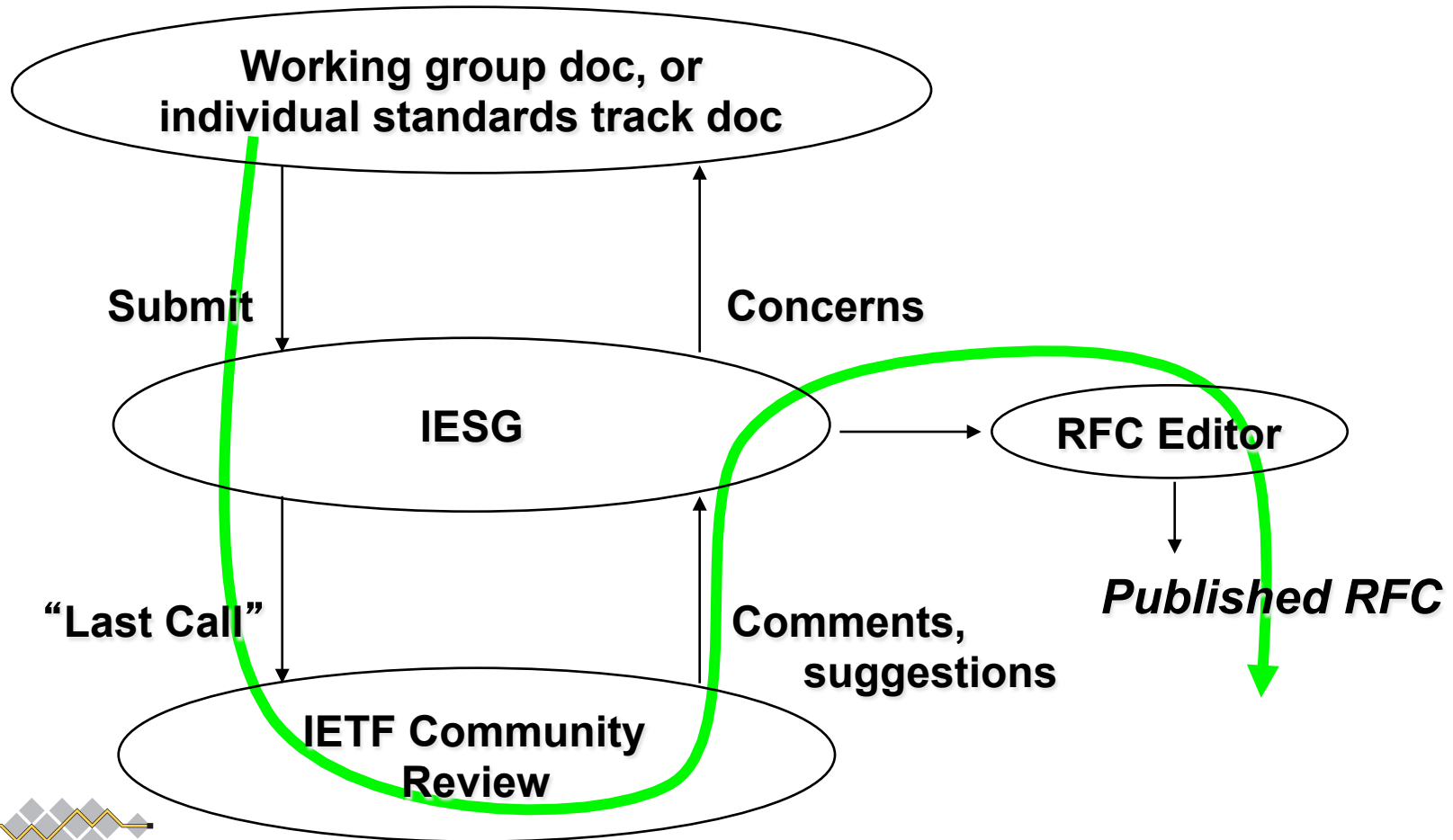

# Non-IETF Submissions

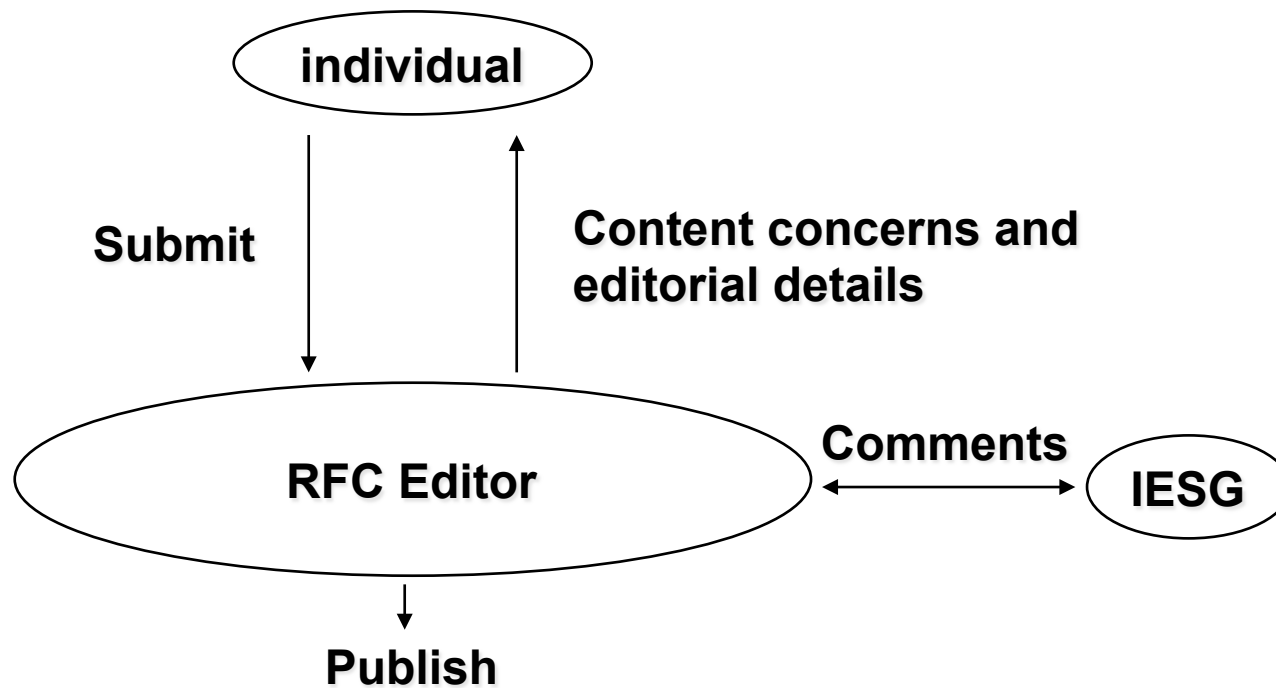



# Standards Track RFCs:

Best Current Practices (**BCP**)

policies or procedures (best way we know how)

3-stage standards track (not all that well followed)

Proposed Standard (**PS**)

good idea, no known problems

Draft Standard (**DS**)

PS + stable

multiple interoperable implementations

note: **interoperability** not conformance

Internet Standard (**STD**)

DS + wide use

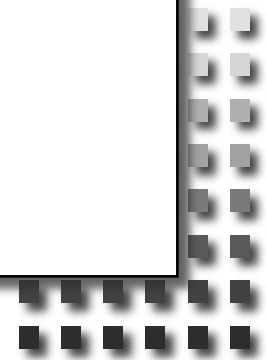





# Other RFC Types

Informational

Experimental

Historical



I E T F®

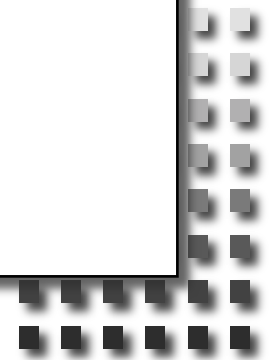



# Appeals Process

IETF decisions can be appealed

start level above decision being appealed

1st to the WG chair(s)

only then to the Area Director

only then to the IESG

only then to the IAB

if claim is that **the process** itself is broken, (not that the process was not followed)

then an appeal can be made to the ISOC Board (after the above is complete)

it is OK to appeal decisions – people do (& succeed)

but appeals are not quick



starting “low” is the right thing to do

I E T F®





# Working Group Session

WGs only meet for a few hours at an IETF meeting  
most working group work must be done on mailing lists  
often only specific unresolved issues discussed at meeting  
so read the IDs before the session

advice: listen (and read) before speaking

sessions are being streamed & recorded

so speak directly into the mike

say your name - **every** time you get to the mike

for the people in audio-land & for the scribe

sign the blue sheets

record of who is in the room - required for openness



retained but not published

I E T F®

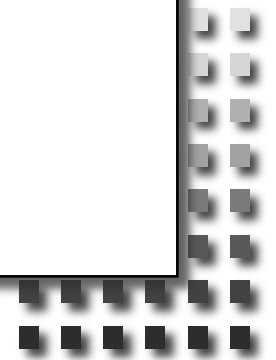



# Intellectual Property Rights

IPR is a very big issue in standards bodies

what to do if there is a patent on the technology

what about patent applications?

what if you do not know until it's already a standard?

patent questions:

should you demand free rights to implement?

require "fair & non-discriminatory" licensing?

what if IPR claim is false?

e.g. an attempt to block the standard

should the standards body evaluate validity of patents?

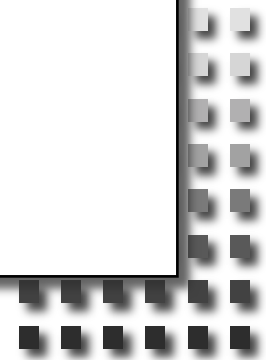

# Patents - Issues

getting pressure from the open source folk for standards with no (known?) IPR

maybe in some parallel universe

see AU "Innovation Patent" AU 2001100012 A4 <sup>(8/01)</sup>

also U.S. Patent 5,443,036 <sup>(8/95)</sup>

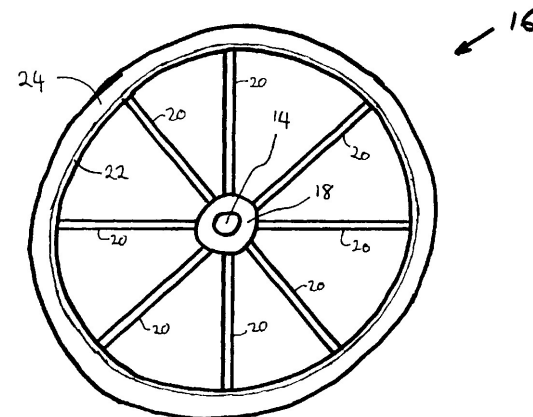
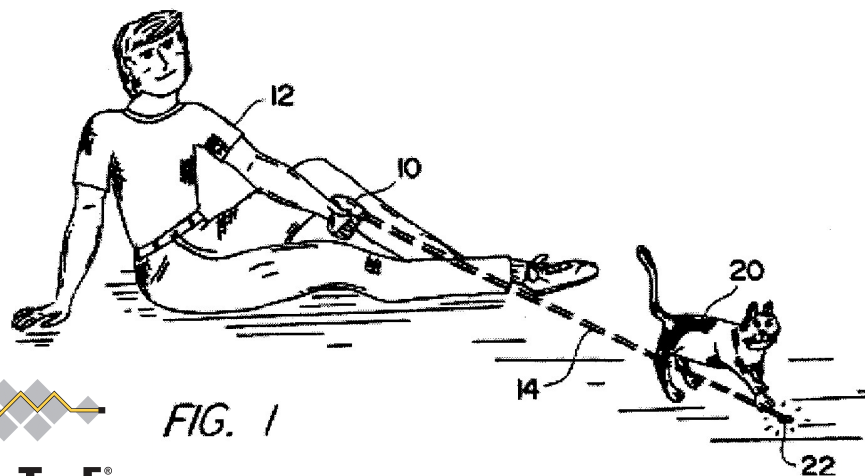



# IPR (Patents)

RFC 2026 revised IETF IPR rules

used to require “fair & non-discriminatory” licensing  
some standards blocked using old process

now use standards sequence to check IPR issues

require multiple implementations based on multiple  
licenses to progress to Draft Standard or Internet  
Standard

but a worry about “submarine patents”

IPR working group

clear up fuzzy language in RFC 2026

produced RFC 3978 and RFC 3979

tweaked by RFC 4748 to recognize the IETF Trust



I E T F®



# IPR, contd.

IETF IPR (patent) rules (in RFC 3979)

require timely **disclosure** of your own IPR in your own submissions & submissions of others

“**reasonably and personally**” known to the WG participant

i.e., no patent search required

**WG** takes IPR into account when choosing solution

RFC 3669 gives background and guidance

push from open source people for RF-only process

consensus to not change to mandatory RF-only

 but many WGs **tend** to want RF or IPR-free

**I E T F**® or assumed IPR-free



# IPR (Copyright)

author(s) need to give non-exclusive publication rights to IETF Trust if to be published at all

also (normally) the right to make derivative works

author(s) **retain** all other rights

mandatory ID boilerplate statement

- 1/ agreement that IPR disclosures have been (or will be) made
- 2/ (optional) no right to produce derivative works  
not permitted for standards track documents
- 3/ (optional) just publish as ID
- 4/ Copyright statement





# Note Well (1)

The “Note Well” statement shows up a lot at the IETF.  
Mailing lists, registration, meeting openings, etc.

“Any submission to the IETF intended by the Contributor for publication as all or part of an IETF Internet-Draft or RFC and any statement made within the context of an IETF activity is considered an "IETF Contribution".

*continued ...*



## Note Well (2)

“Such statements include oral statements in IETF sessions, as well as written and electronic communications made at any time or place, which are addressed to:

- the IETF plenary session
- any IETF working group or portion thereof
- the IESG, or any member thereof on behalf of the IESG
- the IAB or any member thereof on behalf of the IAB
- any IETF mailing list, including the IETF list itself, any working group or design team list, or any other list functioning under IETF auspices
- the RFC Editor or the Internet-Drafts function”

*continued ...*



## Note Well (3)

“All IETF Contributions are subject to the rules of RFC 3978 (updated by RFC 4748) and RFC 3979.

Statements made outside of an IETF session, mailing list or other function, that are clearly not intended to be input to an IETF activity, group or function, are not IETF Contributions in the context of this notice.

Please consult RFC 3978 and RFC 4748 for details.”

*continued ...*



# Note Well (4)

A participant in any IETF activity is deemed to accept all IETF rules of process, as documented in Best Current Practices RFCs and IESG Statements.

A participant in any IETF activity acknowledges that written audio and video records of meetings may be made and may be available to the public.



# Other IETF Training/Tutorials

1300 - 1445 Newcomers Training (you are here)

rerun later in the week

1300 - 1445 Routing, Bridging and Switching Tutorial

1300 - 1445 Introduction to xml2rfc

1500 - 1645 Document Lifecycle

1700 - 1900 Welcome Reception

*(talking to IETF people is often quite an education!)*



# What next?

*join mailing lists*

*this is where the work happens*

*read (and understand) before writing*

*read the drafts*

*don't be shy*

*talk to people*

*look for common ground*

*help people*

*don't settle for second-rate*



I E T F®

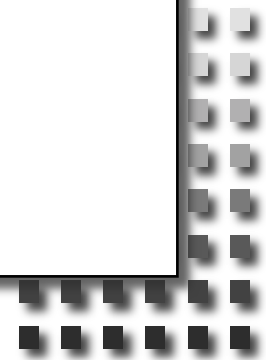

# Questions?



I E T F®