



# IETF Structure and Internet Standards Process

*Scott Bradner*

*86th IETF  
Orlando, Florida, USA*





# Agenda

IETF history & overview

IETF role & scope

IETF structure & associated groups

IETF management & selection

IETF process & procedure

a working group session

intellectual property rights (IPR)





# The IETF

Internet Engineering Task Force  
formed in 1986

evolved out of US ARPANET-related government activities

Internet Configuration Control Board (ICCB) (1979) and Internet  
Activities Board (1983)

was not considered important for a long time - good!!

not “government approved” (US or other) - great!!

although funding support from U.S. Government until 1997

people not companies

*“We reject kings, presidents and voting. We believe in  
rough consensus and running code”*

Dave Clark (1992)





# IETF Overview

## Internet Standards R Us

most Internet-related standards were developed or are maintained by the IETF

not including physical network or page display standards

does not exist (in a legal sense), **no** members, **no** voting

The IETF is “*an organized activity of the Internet Society*”

1K to 1.5K people at 3/year meetings

many, many more on mail lists



# IETF Meeting Attendance

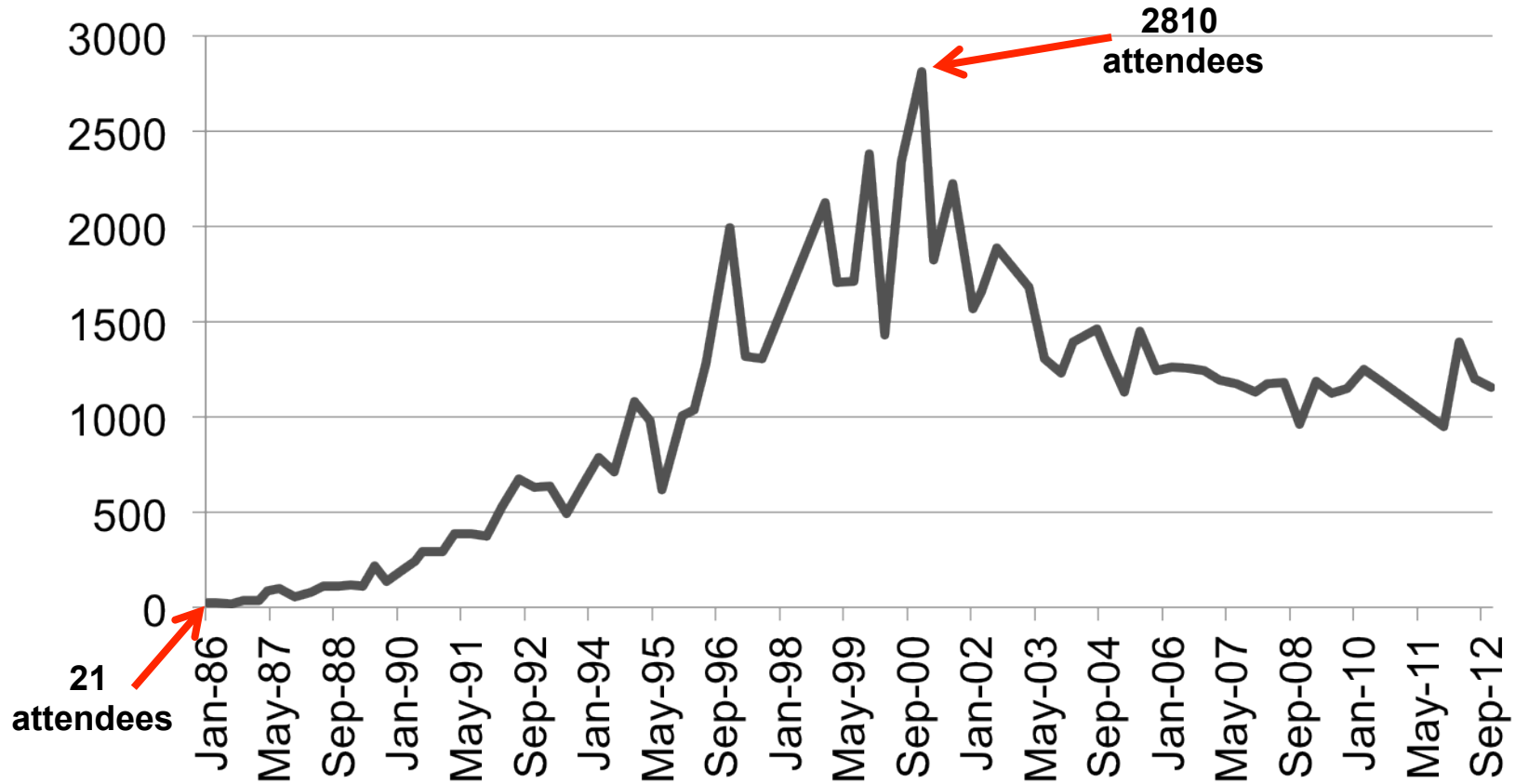



# IETF Work Team

123ish **working groups (WGs)** (where the stuff happens) (was 134 in November)

anyone can participate in WGs

8 **areas** (for organizational convenience) with Area Directors (**ADs**)

APS, GEN, INT, O&M, RAI, RTG, SEC, TSV

**Internet Engineering Steering Group (IESG):**  
management (ADs + IETF Chair)

**Internet Architecture Board (IAB):** architectural  
guidance & liaisons

IETF produces **standards** and other documents





# IETF “Standards”

IETF standards: not ‘because we say so’ standards  
they are standards only if people **use** them

formal SDOs can create legally mandated standards

**no** formal recognition for IETF standards

by governments or “approved” standards organization

but some government standards refer to IETF standards

lack of formal government input “a problem”

at least to some governments

**no** submitting to “traditional” standards bodies





# The Role & Scope of the IETF

*‘above the wire and below the application’*

IP, TCP, email, routing, IPsec, HTTP, FTP, ssh, LDAP,  
SIP, mobile IP, ppp, RADIUS, Kerberos, secure email,  
streaming video & audio, ...

but wires are getting fuzzy

MPLS, GMPLS, pwe3, VPN, ...

generally hard to clearly define IETF scope

IETF is constantly exploring the edges

e.g. (IP) telephony







# Scope of Other SDOs

the Internet (& the Internet protocols) are very interesting to other standards development organizations (SDO)

Internet is becoming the underpinnings of the entire world telecommunications business

other SDOs trying “fix” or “extend” IETF protocols

they may be trying to solve a different problem  
or are making different assumptions

problem: what happens when these extensions break underlying protocol assumptions or make non-interoperable versions?

SDO (including IETF) assumption: each SDO modifies its own protocols



but see dispute with ITU-T over MPLS for transport

I E T F®

# Top Level View of IETF Organization

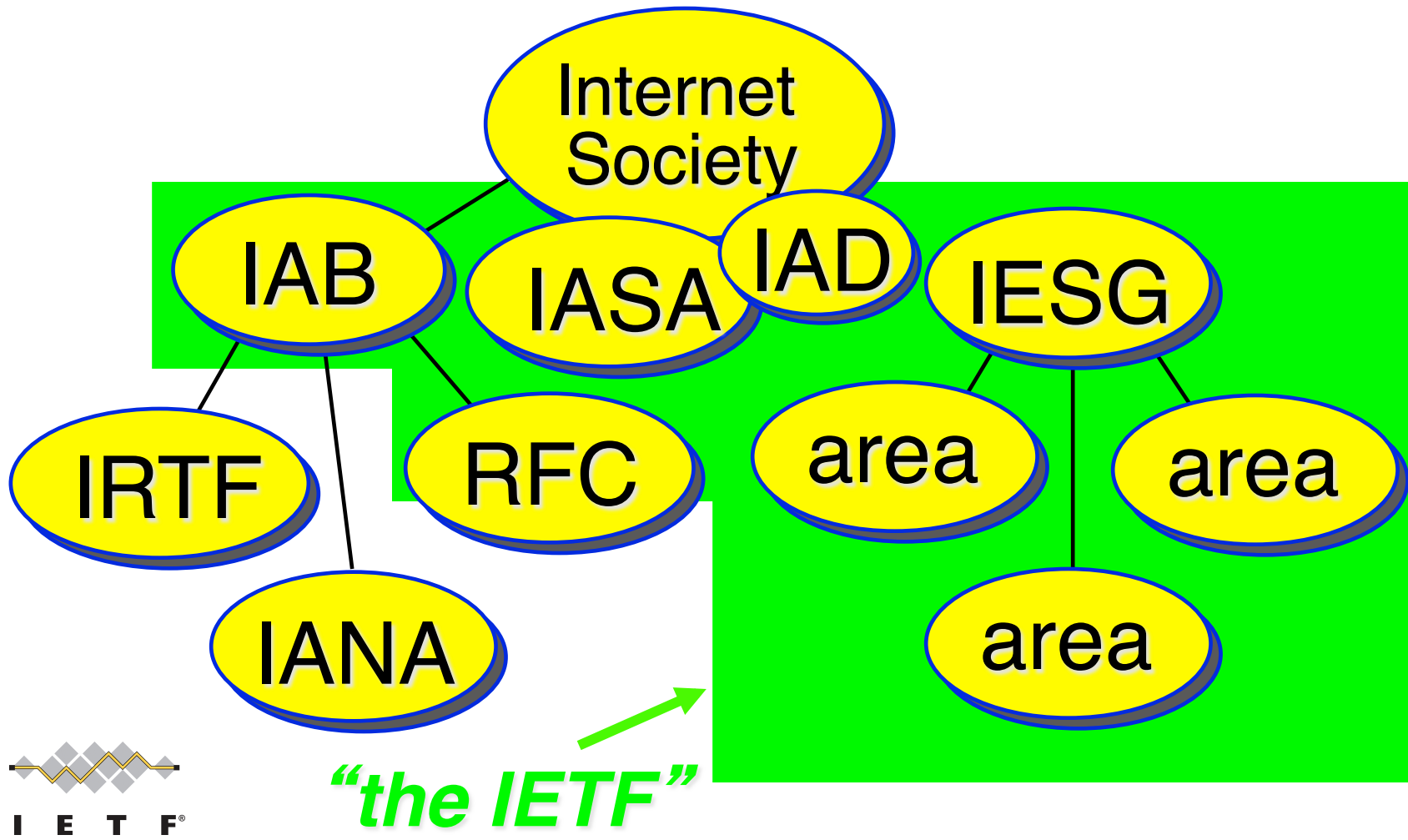

# The Internet Society (ISOC)

non-profit, non-governmental, independent, international organization

more than 130 organizational members & more than 55,000 individual members & about 90 chapters in 72 countries

formed 1992 to:

provide legal umbrella over IETF

continue Landwebber developing country workshops

mission:

*“To promote the open development, evolution, and use of the Internet for the benefit of all people throughout the world.”*

join at [www.isoc.org](http://www.isoc.org)



## ISOC, contd.

IETF agreed to come under ISOC umbrella in 1996  
after a (long) open working-group-based discussion

ISOC is now the organizational and administrative  
home for IETF

legal umbrella, insurance, IASA home, IAD employer,  
etc.

ISOC Board of Trustees part of appeal chain

ISOC President appoints chair of nomcom

IAB chartered by ISOC

ISOC president is on the IAB list & calls

IETF (through IAB) appoints 3 ISOC trustees



# Internet Research Task Force (IRTF)

focused on **long term** problems in Internet

Anti-Spam Research Group (ASRG)

Crypto Forum Research Group (CFRG)

Delay-Tolerant Networking Research Group (DTNRG)

Host Identity Protocol (HIP) Research Group (HIPRG)

Internet Congestion Control Research Group (ICCRG)

Information Centric Networking Research Group (ICNRG)

Network Complexity Research Group (NCRG)

Network Management Research Group (NMRG)

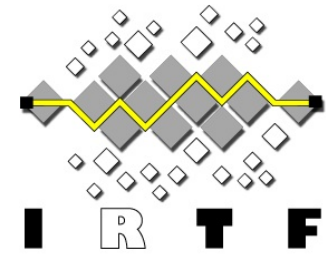



# IRTF, contd.

Peer-to-Peer Research Group (P2PRG)

Routing Research Group (RRG)

Scalable Adaptive Multicast Research Group (SAMRG)

IRTF chair appointed by IAB

see <http://www.irtf.org>

IRTF Chair: Lars Eggert



# Internet Architecture Board (IAB)

provides overall **architectural advice** & **oversight**  
to IESG, IETF, IRTF & ISOC

approves IESG slate from nomcom

step in appeals chain

provides “oversight” of IETF standards process

deals with IETF external liaisons

appoints IRTF chair

selects & oversees IETF-IANA

appoints & oversees RFC Editor

chartered by & advises the ISOC Board



# IAB, contd.

voting members

12 IAB members (6/year for 2-year terms)

IETF Chair

non-voting

IAB Executive Director

IRTF Chair

liaisons from ISOC, IESG, RFC Editor, and IANA

*IAB members also act as  
individual IETF participants*





# IAB Oversight Mechanisms

review BOFs for IESG

provide input to IESG on WG formation & charters

sponsor & organize IRTF

convene topic-specific workshops

mostly invitation only

organize ad-hoc expert groups to adjudicate technical disputes

write IDs/RFCs stating IAB opinion

with community & IESG review

participate in WG discussions





# IAB Programs

established in 2010

long term activity, scoped and managed by the IAB  
form team for each program; IAB & non-IAB people  
usually led by an IAB member

goals:

do more work,

involve non-IAB people

improve continuity across IAB membership changes

see <http://www.iab.org/activities/programs/>





# IAB Programs, Contd.

## Current IAB Programs

RFC Editor Program: The RSOC (example: RFC 6548)

Privacy Program (example: RFC 6462)

Liaison Oversight Program

ITU-T Coordination Program (example: RFC 6756)

IP Evolution (example: RFC 6250)

Internationalization Program (example: RFC 6055)

IANA Evolution Program (example: RFC 6220)

IAB Tools and Processes Program

Emergency Services



# Internet Assigned Number Authority (**IANA**)

assigns numbers and keeps them from colliding

assigns protocol numbers (ports, MIME types, etc)

IP addresses

assigns address blocks to 5 regional IP Address registries

which assign addresses to ISPs and end sites

domain names

defines top level domains (TLDs) - e.g., .com, .ca, .us, ...

maintains root server database of TLD server addresses

the IANA predates the IETF



# IANA Contd.

functions generally came under IETF after IETF was formed

funded by US government until 1998

functions split from IETF with the creation of Internet Corporation for Assigned Names and Numbers (ICANN) in 1998

independent corporation, took over IANA functions  
now IETF-IANA and non-IETF-IANA

separate US government contract with ICANN for IANA functions

renewed in July 2012 for 3 years (with 2 2-year options)





# IETF-IANA

operates under MoU between ICANN and IETF

RFC 2860

assigns protocol parameters for IETF protocols

but not funded by IETF

IP protocol numbers

well known TCP/UDP ports

PPP protocol ids

MIME types

special use IP addresses

etc.





# IETF Management

## IETF Chair

AD for General Area, chief spokesperson

## Area Directors (ADs)

manage individual areas (two per regular area)

## Internet Engineering Steering Group (IESG)

ADs + IETF Chair sitting as a body

## Internet Architecture Board

IETF chair is part of IAB

## IETF management selected by nomcom

two year terms





# IETF Management, contd.

IETF management are all volunteers

AD job: half to 3/4 time

IAB job: 1/3 time

IETF Chair job: full time

IETF does not pay ADs, IAB members, IAOC members, WG chairs or IETF Chair a salary or expenses

people are company- or self- supported

secretariat, RFC publication support & IAD are paid





# IETF Chair

Jari Arkko <chair@ietf.org>

also chair of the **IESG**

also AD of the **General Area**

also ex officio member of the **IAB**

nominated by IETF community - this now includes you  
selected by nomcom

IETF's "CTO" - "Chief Talking (& Traveling) Officer"





# Area Directors (ADs)

Areas have 2 ADs

- except General Area, which has one
- responsible for setting direction in Area
- responsible for managing process in Area
- approve BOFs & propose working groups
- review working group documents
- prior to IESG review

# IESG

Internet Engineering Steering Group

ADs + IETF Chair

**process management and RFC approval body**

approves WG creation (with IAB advice)

**provides cross-area technical review** & approves  
publication of IETF documents

reviews and comments on non-IETF RFC submissions

**multi-disciplinary technical review** group





# Selecting IETF Management

picked by a nominations committee (nomcom)

nomcom chair appointed by ISOC president

process described in RFC 3777

members selected randomly from list of **volunteers**

requirement: present at 3 of last 5 IETF meetings

very random process to select from volunteers: RFC 3797

gets list of jobs to fill

can include IETF Chair, IESG, IAB & IAOC members

nominate one person for each job

IAOC selections approved by IESG, IESG & IETF Chair

selections approved by IAB, IAB selections approved by

ISOC BoT





# IETF Areas

General Area (**gen**) - 0 WGs (as of 2/2/2013)

Applications (**app**) - 13 WGs

Internet (**int**) - 25 WGs

Operations & Management (**ops**) - 15 WGs

Real-time Applications and Infrastructure (**rai**) - 27 WGs

Routing (**rtg**) - 19 WGs

Security (**sec**) - 12 WGs

Transport Services (**tsv**) - 14 WGs





# IETF Secretariat

Association Management Solutions, LLC - Fremont, CA,  
USA

managed by IETF Administrative Support Activity (IASA)

runs

plenary meetings, mailing lists,

Internet-Draft & directory, IESG teleconferences

coordinates

day to day work of IESG



# IETF Administrative Support Activity (IASA)

provides the administrative structure required to support the IETF standards process: see RFCs 4071 & 4371

**has no authority over the standards process**

housed within the Internet Society

creates budget for IETF

money from meeting fees & from ISOC

responsible for IETF finances

contracts for IETF support functions

Secretariat functions, RFC evaluation and publication & IETF-IANA

deals with IETF IPR





# IASA, contd.

includes

IETF Administrative Director (**IAD**) - Ray Pelletier

ISOC employee

day to day operations oversight

IETF Administrative Oversight Committee (**IAOC**)

8-member body

IAB & IETF chairs & ISOC president

plus

members selected by nomcom (2), IAB, IESG & ISOC





# IETF Trust

created in Dec 2005 to hold IETF IPR

copyrights (on RFCs etc)

domain names (e.g., ietf.org)

trademarks

software paid for by IETF

databases

etc

IPR created under the secretariat contract goes to Trust  
(not a patent pool)



# Dots

 IAB member (red)

 IRSG member

 IESG member (yellow)

 Working Group chair (blue)

 nomcom (orange)

 Local host (green)

 IAOC member (purple)



 IETFer specifically happy to help



# Working Groups

this is where the IETF primarily get its work done

most discussions on a WG mailing list

face-to-face meetings focused on key issues (ideally)

note: face-to-face meetings generally quite short

“bottoms up”

i.e., generally proposed by IETF participants, not ADs

sometimes preceded by a BOF



# Birds of a Feather Sessions (BOF)

often precedes the formation of a Working Group  
group of people interested in a topic

convince an AD that they have a good idea - one  
worth exploring & there are enough interested  
people to do the work

need description and agenda before a BOF can be  
scheduled

and sometimes a draft charter for a working group

BOFs generally only meet once

can lead to a WG or can be a one time thing



# Working Groups

Working Groups are focused by charters agreed between WG chair(s) and area director  
restrictive charters with milestones  
charter approved by IESG with IAB advice  
after public announcement for comments  
announcement goes to other SDOs to check for overlaps  
IESG has final say on charter  
working groups are closed when their work is done  
at least in theory

# Working Group Creation

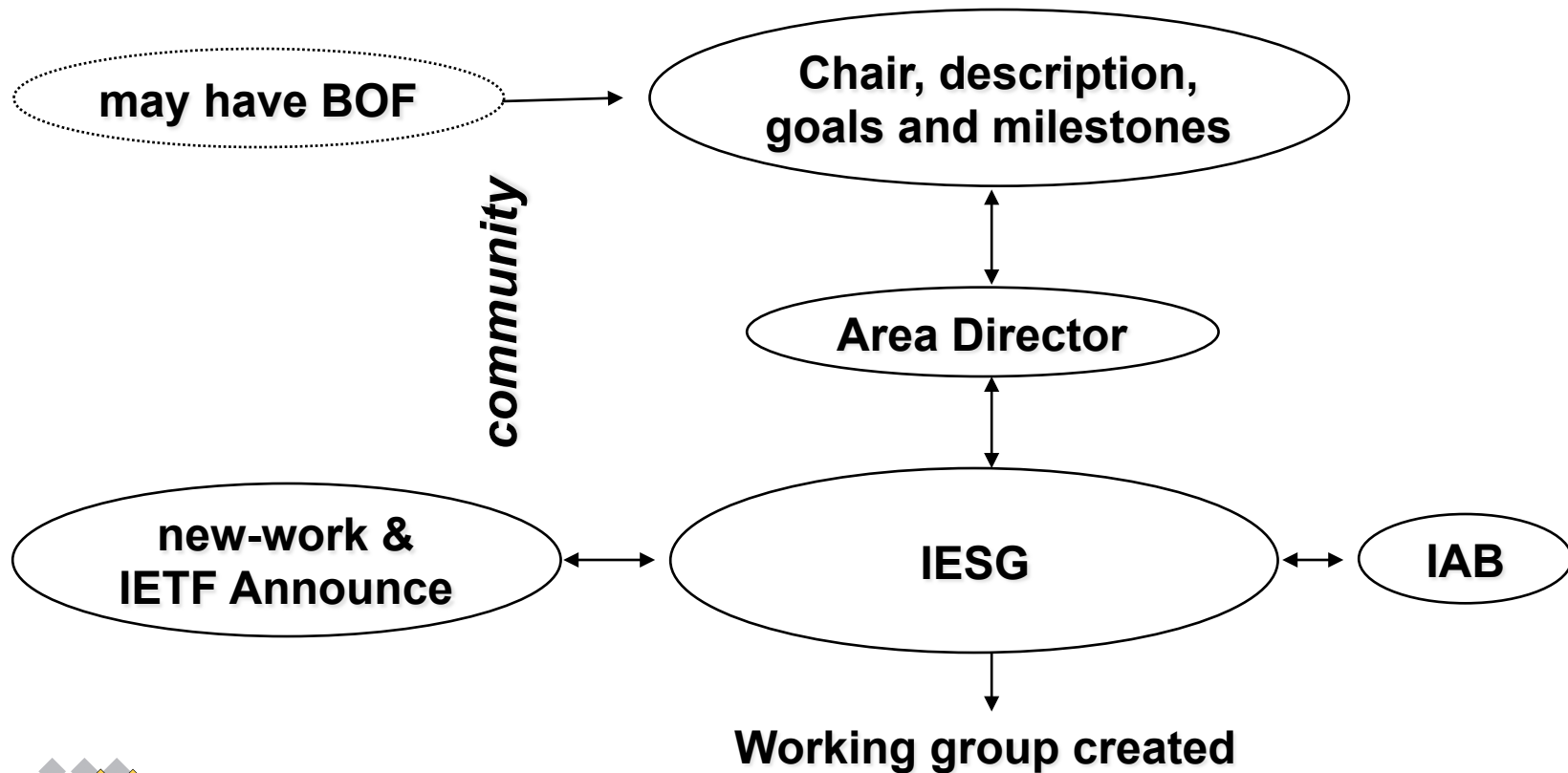



# Working Groups. contd.

no defined membership

just participants

“***Rough consensus** and running code...*”

no formal voting (can not define the constituency)

can do show of hands or hum - but **no** count

does **not** require unanimity

chair determines if there is consensus

disputes resolved by discussion

mailing list and face-to-face meetings

final decisions must be verified on mailing list

to ensure those not present at face-to-face are included

but taking into account face-to-face discussion





# IETF Document Format

English is the official language of the IETF

but blanket permission is given to translate any IETF document  
(in total) into any language for any reason

ASCII is the mailing list and document format

constant discussion of alternate formats

IETF seen as “behind the times” - e.g., (almost) no  
drawings - but no consensus on alternative format

note that the current format is still readable after 44 years  
(see RFC 20 for an example)

how many other SDOs can claim that?







# Standards Process

technical proposals published as Internet Drafts (ID)  
worked on in a Working Group

WG sends IESG request to publish an ID 'when ready'  
proposal reviewed by AD responsible for WG

can be sent back to working group for more work

2-week IETF-wide Last-Call

4-week Last Call if individual standards track submission

IESG review

last call comments + own technical review

can be sent back to Working Group for more work

publication as RFC





# IETF Documents

all IETF documents are **open**

i.e., anyone can download and make copies (in full)

## Internet Draft

IETF working documents

**some** I-Ds are working group documents

## RFC

archival publications (never changed once published)

update or correction gets new RFC number

many different types of RFCs





# IETF Working Documents

## Internet-Draft

random or non-random thoughts

input to the process

**no admissions control** other than boilerplate (see IPR)  
in theory, removed from **IETF** ID directory after 6 months  
unless updated or under IESG consideration  
but many mirrors exist, including in IETF Tools

all RFCs must pre-exist as IDs

to deal with IPR handoff, etc

(other than some IANA or RFC Editor created ones)





# What is a RFC?

RFC used to stand for “Request for Comments”

now just a (brand) name

now tend to be more formal documents than early RFCs

IETF document publication series

RFC 1 *Host Software* - Apr 7 1969

now over 6000 RFCs

**not all RFCs are standards!**

see RFC 1796

though some vendors sometimes imply otherwise

many types of RFCs



# RFC Repository Contains:

standards track

OSPF, IPv6, IPsec ...

obsolete Standards

RIPv1

requirements

Host Requirements

policies

Classless InterDomain

Routing

april fool's day jokes

IP on **Avian Carriers** ...

... updated for QoS

poetry

'Twas the night before startup

white papers

On packet switches with  
infinite storage

corporate documentation

Ascend multilink protocol

experimental history

Netblt

process documents

IETF Standards Process





# RFC Editor

IETF publication arm

was one person, then one function

now multiple parts

- oversight (RFC Series Editor - RSE)

- editing (RFC Production) - done by AMS

- publishing (RFC Publisher) - done by AMS

- independent submissions ( Independent Submissions Editor - ISE)

  - RSE & ISE selected & appointed by IAB



# RFC Production & Publishing

receives requests to publish IDs from multiple streams

IETF (via IESG)

IRTF (via IRSG)

IAB

Independent Submissions (via ISE)

edits IDs for publication

verify edits with authors

publishes RFCs





# Independent Submissions Editor

ISE gets requests to publish IDs

can only publish informational or experimental RFCs

asks IESG for advice

but can exercise own discretion to publish or not

presumption is to publish technically  
competent and useful IDs

which sometimes is a conflict with IESG



# IETF Submission

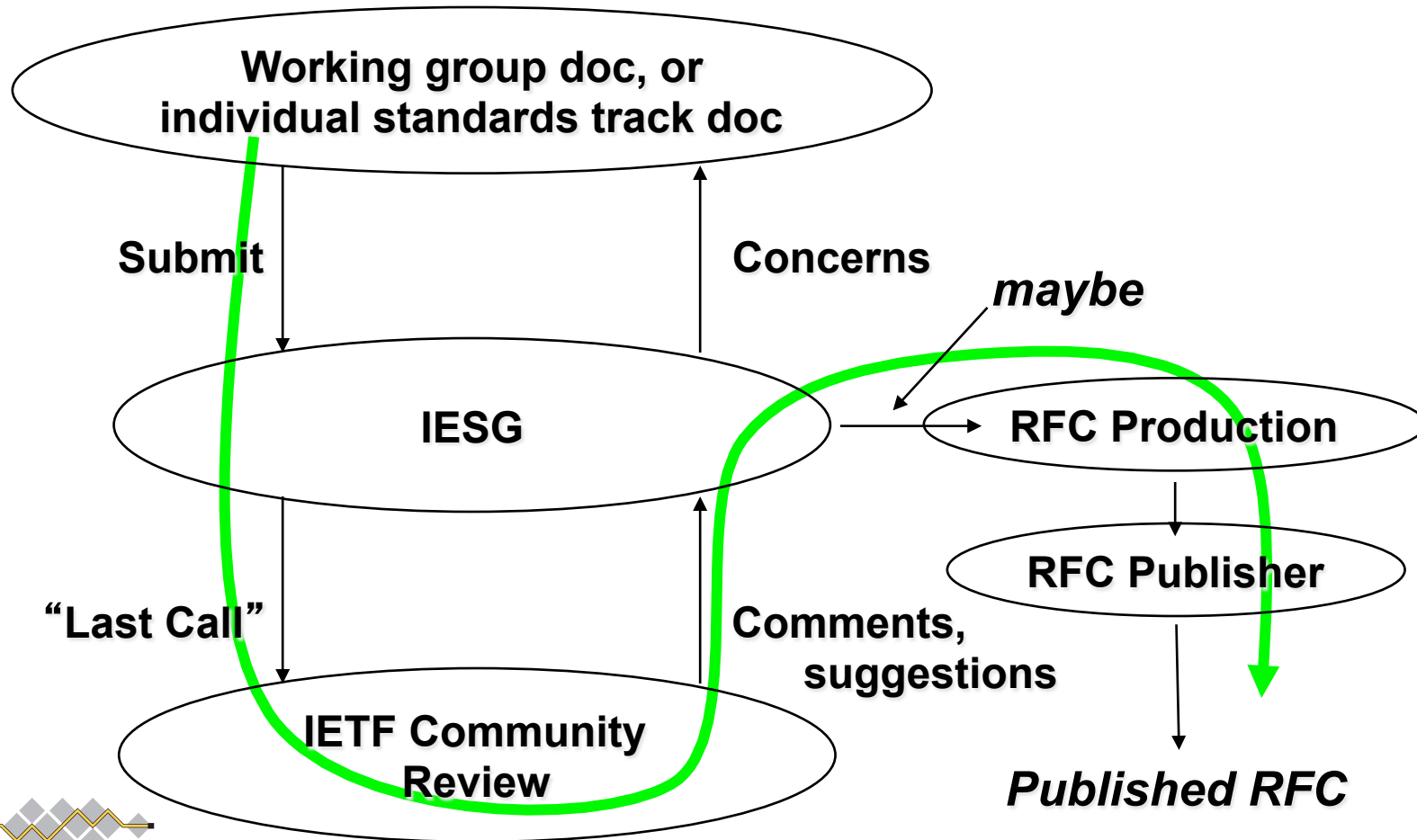

# Non-IETF Submissions

*(The IAB & IRTF have their own procedures)*

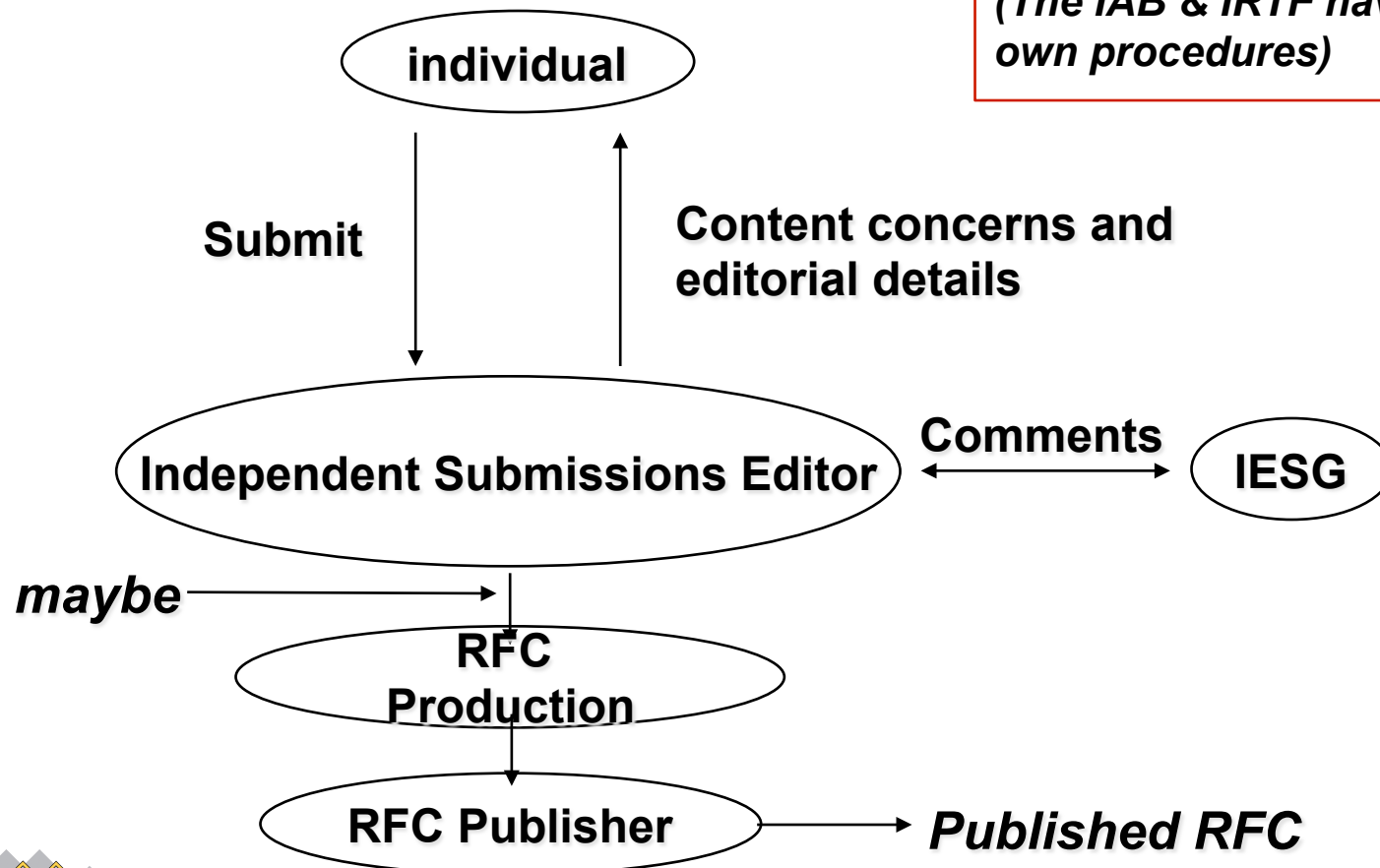

# Standards Track RFCs:

## Best Current Practices (**BCP**)

policies and procedures (best way we know how)

## 3-stage standards track (not all the way followed)

### Proposed Standard (**PS**)

good idea, no known problems

### Draft Standard (**DS**)

PS + stable

multiple implementations, multiple implementations improve document clarity

not **interoperability** not conformance

### Internet Standard (**STD**)

DS + wide use

T F®



# Standards Track RFCs:

Best Current Practices (**BCP**)

policies or procedures (best way we know how)

2-stage standards track (changed Oct 2011 - RFC 6410)

Proposed Standard (**PS**)

good idea, no known problems

Internet Standard (**STD**)

PS + stable + “benefit to Internet community”

multiple interoperable implementations to prove document clarity

note: **interoperability** not conformance



# Other RFC Types

Informational

Experimental

Historical

*“The Internet runs on proposed standards” – perhaps first said by Fred Baker, IETF Chair 1996-2001*

***always check the current status of an RFC before relying on it. A new RFC may have obsoleted or updated the one you are looking at***

*you can find out by looking at the RFC index*





# Appeals Process

IETF decisions can be appealed

start level above decision being appealed

1st to the WG chair(s)

only then to the Area Director

only then to the IESG

only then to the IAB

if claim is that **the process** itself is broken, (not that the process was not followed)

then an appeal can be made to the ISOC Board (after the above is complete)

it is OK to appeal decisions – people do (& succeed)

but appeals are not quick



starting “low” is the right thing to do

I E T F®



# A Working Group Session

WGs only meet for a few hours at an IETF meeting  
most working group work is done on the WG mailing list  
often only specific unresolved issues are discussed at meetings  
so read the IDs and mailing list before the session

advice: listen (and read) **before speaking**

sessions are being streamed & recorded

so speak directly into the mike (don't look at the questioner)

say your name - **every** time you get to the mike

for the people in audio-land & for the scribe(s)

sign the blue sheets

record of who is in the room - required for openness



published but not retained

I E T F®



# Intellectual Property Rights

IPR is a very big issue in standards bodies

what to do if there is a patent on the technology

what about just a patent application?

what if you do not know until it's already a standard

when you find out about a patent?

patent questions:

should you demand free rights to implement?

require "fair & non-discriminatory" licensing?

what if IPR claim is false?

e.g., an attempt to block the standard

should the standards body evaluate validity of patents?



# Patents - Issues

lots of patents in the world

some very good, some not so good

getting pressure from the open source folk for standards with no (known?) IPR

maybe in some parallel universe

see AU "Innovation Patent" AU 2001100012 A4 (8/01)

also U.S. Patent 5,443,036 (8/95)

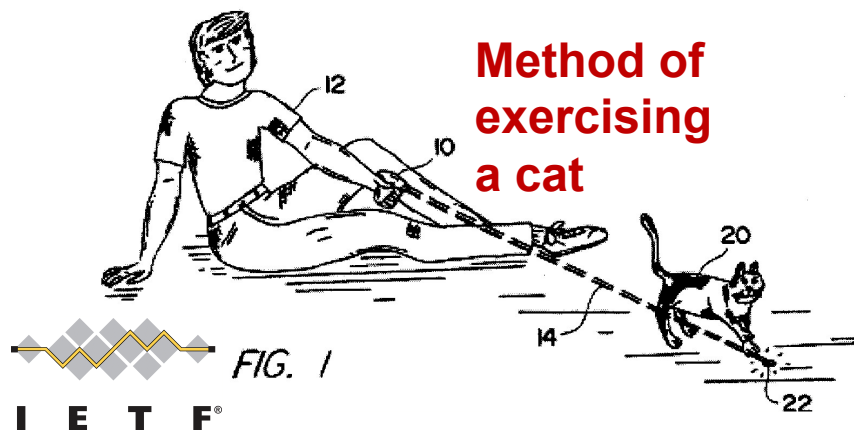

**Circular transportation facilitation device**

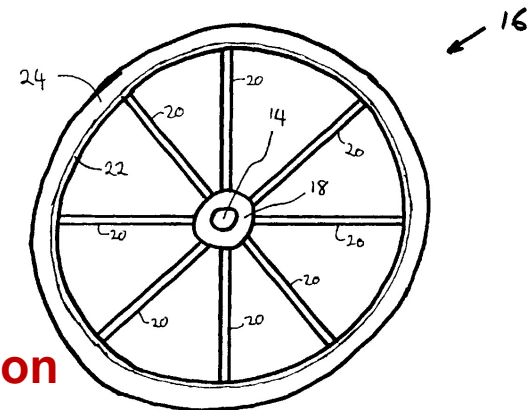



# IPR (Patents)

RFC 2026 revised then existing IETF IPR rules  
used to require “fair & non-discriminatory” licensing  
standards could be blocked using old process  
now use standards sequence to check for IPR issues  
by requiring multiple implementations based on multiple  
licenses to progress on standards track  
but a worry about “submarine patents”  
patent rules part of RFC 2026 replaced by RFC 3979 &  
RFC 4879  
mostly clarifications  
revision in the works – BOF Tuesday 15:20

# IPR, contd.

IETF IPR (patent) rules (in RFC 3979)

require timely **disclosure** of your own IPR in your own submissions & submissions of others

disclosures published on IETF web site

“**reasonably and personally**” known to the WG participant

i.e., no patent search required

**WG** may take IPR into account when choosing solution

RFC 3669 gives background and guidance

push from open source people for RF-only process

consensus to not change to mandatory RF-only

but many WGs **tend** to want RF or IPR-free

(or at least assumed to be IPR-free)





# Patents, Cases

“your IPR” = an issued patent or a patent application that is owned directly or indirectly, by you or your employer or sponsor (if any) or that you otherwise have the right to license or assert

example cases:

A/ you want to submit an ID, some part of which covered by your IPR

B/ you see that someone from your company submitted an ID, or says something at a mic, some part of which covered by your IPR

C/ you discover your IPR that covers some part of a published ID or RFC from you or someone at your company

in these cases you or the someone **MUST** make an IPR disclosure as soon as reasonably possible



*Many companies insist that company lawyers do this.*



# Patents, Cases, contd.

example case:

D/ you find an ID or RFC submitted by someone else, some part of which covered by your IPR

two situations:

1/ you or someone from your employer or sponsor participates in any WG where the ID or RFC is discussed or otherwise participates in any discussion of the ID or RFC

in this situation you or your company **MUST** make an IPR disclosure as soon as reasonably possible

2/ situation #1 is not the case

in this situation, you **SHOULD** make an IPR disclosure as soon as reasonably possible



# Patents, Cases, contd.

example case:

E/ you know of IPR, other than your own IPR, which covers some part of an ID or RFC

in this case you **MAY** make an IPR disclosure

the IETF Secretariat will attempt to contact the IPR holder and ask for an IPR disclosure statement

remember – by participating in the IETF, you are agreeing to abide by its IPR rules

if you are in any doubt, consult the WG chair *and* your employer's legal experts – the IETF will not give legal advice



# IPR (Copyright)

author(s) need to give non-exclusive publication rights to IETF Trust if to be published at all

also (normally) the right to make derivative works

this right required for standards track documents

author(s) **retain** all other rights

updated by RFC 5378

expanded rights granted to IETF Trust

issue with text copied from older IDs and RFCs

IETF Trust released a FAQ on IETF copyright

see <http://trustee.ietf.org/faqs.html>



# Note Well (1)

The “Note Well” statement shows up a lot at the IETF.

Mailing lists, registration, meeting openings, etc.

defines “contribution” and requires obeying IETF rules

“Any submission to the IETF intended by the

Contributor for publication as all or part of an IETF Internet-Draft or RFC and any statement made within the context of an IETF activity is considered an "IETF Contribution".

*continued ...*







## Note Well (2)

Such statements include oral statements in IETF sessions, as well as written and electronic communications made at any time or place, which are addressed to:

- \* The IETF plenary session
- \* The IESG, or any member thereof on behalf of the IESG
- \* Any IETF mailing list, including the IETF list itself, any working group or design team list, or any other list functioning under IETF auspices
- \* Any IETF working group or portion thereof
- \* The IAB or any member thereof on behalf of the IAB
- \* The RFC Editor or the Internet-Drafts function



*continued ...*





## Note Well (3)

All IETF Contributions are subject to the rules of RFC 5378 and RFC 3979 (updated by RFC 4879).

Statements made outside of an IETF session, mailing list or other function, that are clearly not intended to be input to an IETF activity, group or function, are not IETF Contributions in the context of this notice.

Please consult RFC 5378 and RFC 3979 for details.

*continued ...*





## Note Well (4)

A participant in any IETF activity is deemed to accept all IETF rules of process, as documented in Best Current Practices RFCs and IESG Statements.

A participant in any IETF activity acknowledges that written, audio and video records of meetings may be made and may be available to the public.”



# Other IETF Training/Tutorials

1300 – 1450 Newcomer's Training ← you are here

1300 – 1450 IEEE 802.1Q

1500 – 1650 IAOC Overview Session

1500 – 1650 Introduction to RAI Development in the  
IETF Tutorial

1500 – 1650 WG Leadership

1600 – 1700 Newcomer's Meet and Greet

1700 – 1900 Welcome Reception

*(talking to IETF people is often quite an education!)*





# Newcomer's Dinner

informal dinner for newcomer's to chat about their experience

meet at the IETF registration desk at 7:45 PM Monday

shuttle to reasonably priced restaurant

email Stephanie McCammon ([smccammon@amsl.com](mailto:smccammon@amsl.com)) if you would like to attend or for more information





# What next?

*join mailing lists*

*this is where the work happens*

*but read (and understand) before writing*

*read the drafts & contribute*

*don't be shy (but do not come on too strong)*

*talk with (not just to) people*

*look for common ground*

*don't settle for second-rate discussion or technology*

# Questions?

